



**PLAN & PRINT**  
S Y S T E M S I N C.

**KIP 2300**

**HIGH PRODUCTION CCD SCAN SYSTEM**



# KIP 2300 CCD SCANNING SYSTEM

## High Production Scan System

The new KIP 2300 high productivity scanner sets a uniquely high standard for speed, quality and flexibility in a digital image capture system.

Best in class productivity is achieved by a combination of advanced camera based image capture and Super-Speed USB3s Technology for high speed data throughput with no system pauses or slow downs.

Outstanding image quality is delivered through the innovative use of bright white LED light sources for illumination and 600 x 600 dpi image capture resolution.

The KIP 2300 is a high speed scan solution that provides world-class workflow flexibility through its ability to scan face up or face down and scan thick mounted originals and loose sheets of paper from a single unit.

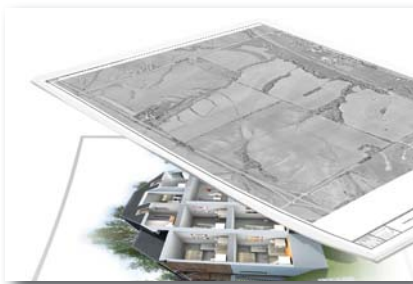

## Versatile Camera Imaging

The KIP 2300 Color Scanner Solution can support both monochrome and color scan-to-file and copy to satisfy most application needs. When scanning to file, users have advanced software controls over image quality; when copying.

The KIP 2300 scanner is powerful, with image capture speeds from 5 ips to 12 ips in monochrome (dependent on dpi) and 2 to 6 ips in color. The image capture area is up to 36 in. wide, yet originals up to 42 in. wide may be fed through the scanner.

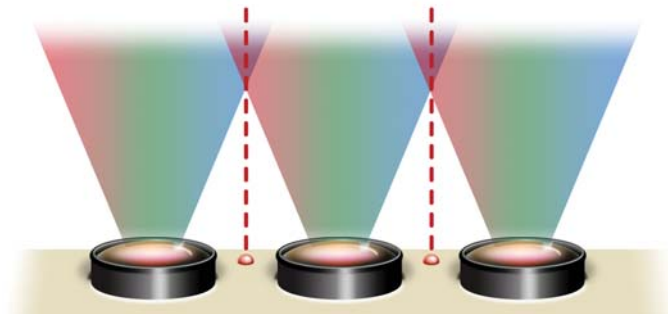
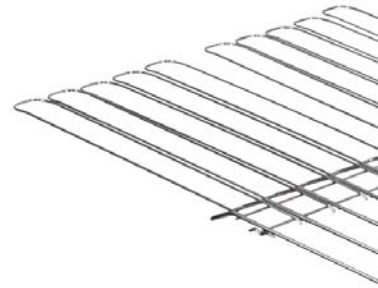

*Three independent imaging cameras with an advanced laser alignment system and self calibrating diagnostics provide an extraordinary level of quality.*



## **Super-Speed USB3** TECHNOLOGY

- **Faster than any other competing image transfer technology**
- **10 times faster than USB 2.0!**
- **Scan documents at full speed and full resolution**
- **No scanning pauses or slow downs**

### **Flexible Scan System**

600 dpi optical resolutions is the key to the KIP 2300 Color Scanner's outstanding imaging capabilities. In addition, the KIP 2300 Color Scanner takes full advantage of patented (Real Time Thresholding) and self calibrating imaging cameras to ensure high quality results.

To optimize image size for intended use, users can select custom resolutions, for website, PC monitor displays and for offset press work.

### **Super-Speed USB3 Technology**

The technology used in Super-Speed scanning provides an image data transfer rate of 5 GB per second, ensuring high productivity for the most complex full color documents. Originals are imaged at maximum speed with no scanning slowdowns or pauses, as found in competitive scanning systems. Super-Speed scanning delivers full color, high speed imaging for the most demanding production environments.



## KIP 720 / 2300 Stand Alone Scan Station

# KIP ImagePro – Scan & Copy

KIP ImagePro – Scan & Copy software is the professional's choice for wide format production Scan & Copy providing a complete set of features for high resolution color and B&W copying & scan-to-file applications. For exclusive use with the KIP 720 and KIP 2300 scanners.

KIP ImagePro tools are designed to enhance color management capabilities. KIP ImagePro offers extensive features for increased productivity including image quality adjustments, high definition viewer with advanced Area of Interest functions, auto document width detection along with Auto Start for stream feeding originals, scan to local drives, LAN locations, USB and cloud storage.

Simplify document quality when scanning or copying difficult originals by selecting B&W point settings on-the-fly adjustments to quickly snap text to solid black or to clean up back ground. Deskew documents automatically. Sophisticated project details can be highlighted with Advanced Area of Interest selections. KIP Smart Stack simplifies the accurate collation of mixed sets of color and black and whites prints. The professional color editor included with KIP ImagePro offers a high definition color editor with real time color correction viewing. Create impressive vibrant color impact for posters, banners, point of purchase, business communications, safety, and technical images. Streamline color correction with color exchange selections from a choice of multiple color spaces for optimal results.

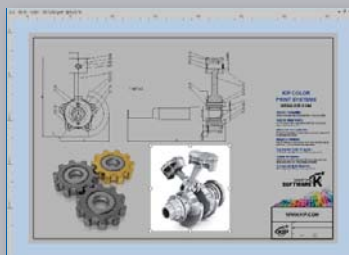

Area of Interest (AOI)

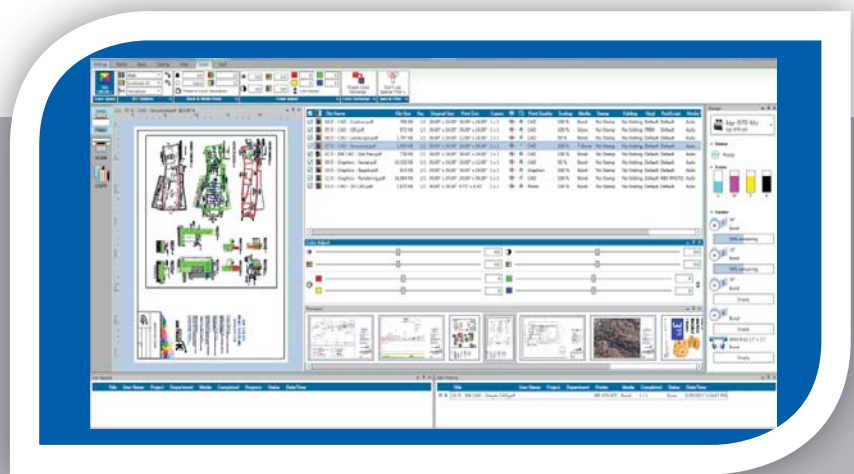

Matrix Scan & Copy with HD Viewer, "Pop out" Panels & Device Status

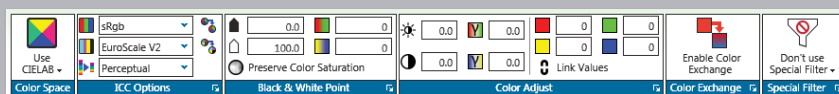

Professional Color Management

## KIP ImagePro Key Features



Auto Start for Stream Feed Productivity | Auto Width Detection | Auto Deskew | Auto Increment of File Name | Advanced Area of Interest Selection | Professional Color Editor & Correction Features | KIP Smart Stacking | High Definition Viewing | Customizable Interface for Personalized View

---

### KIP ImagePro – Scan & Copy Feature Descriptions



#### Stream Feeding Productivity

Auto Start for continuous original document feeding for maximum productivity | Auto De-skew | Auto Width Detection | Auto File Name Increment | Auto Length Detection | Live Preview



#### Advanced Area of Interest

Select Size | Position | Save only the “area of interest” to enhance communication of sophisticated or important details



#### Professional Color Editor & Correction Features

High definition color editor with real time color correction viewing to create impressive vibrant color impact for posters, banners, point of purchase, business communications, safety, and technical images. Streamlines color correction with color exchange selections from a choice of multiple color spaces for optimal results.



#### High Definition Viewing

High resolution image pre-flight viewer to include review of color adjustments and preset creations | Color or B&W | AOI Selection - Scale, Position, Print | Page ruler | View Scale to Pixels or In-Screen



#### Customizable Interface for Personalized View

Access your preferred productivity features with ease using “Pop Out” tools and panels



#### Scan Mode

B&W, Grayscale & Color Scan to File | Scan to Local Drive, USB, LAN or Cloud locations | Wide Variety of File Formats | Scan to Multi-Page PDF and TIF | Set Image Compression | Utilize Templates | Embed Stamps | Control Margins | Mirror and Rotation



#### Copy Mode

Copy to KIP System K B&W and Color Systems | B&W, Grayscale and Color Adjustments | Save Unlimited Presets and Template | Secure Printing | Use Set Separation pages | KIP Accounting Integration | KIP Cost Center Integration

# KIP 2300 SPACE REQUIREMENTS

## KIP 2300 Scanning System Space Requirements

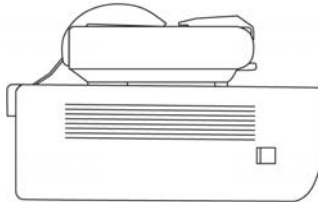

KIP 2300 Side View

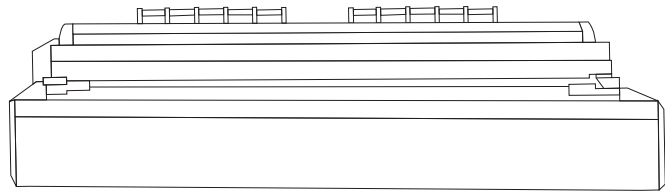

KIP 2300 Front View

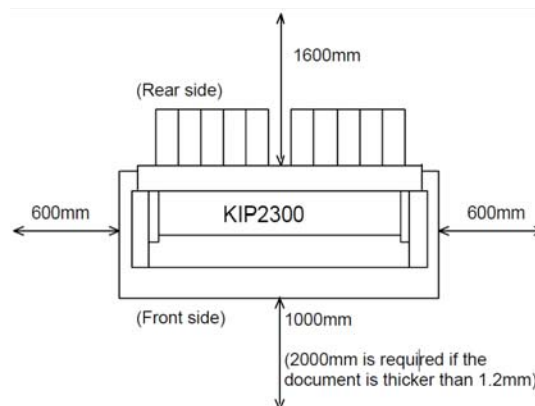

KIP 2300 Top View

# KIP 2300 SPECIFICATIONS

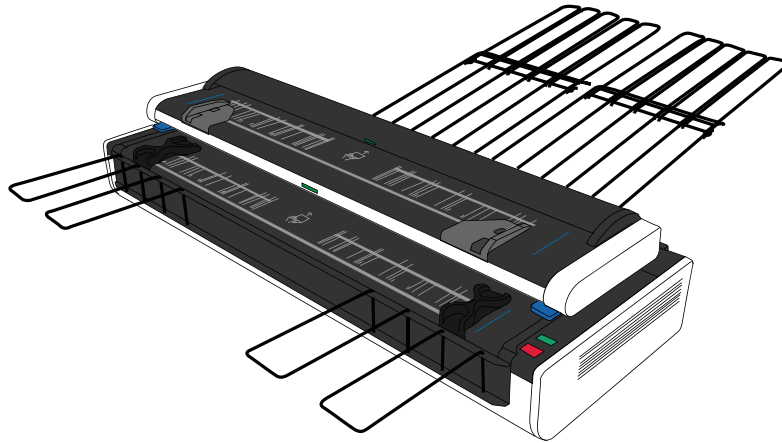

General	
Scanner Type	C.C.D. with Super-Speed USB3 Technology and KIP RTT Technology
Scan Resolution	600 x 600 dpi optical resolution
Scan Speed	Up to 12 ips / 305 mm per second (B&W) Up to 6 ips / 152 mm per second (Color)
Scan Formats	TIFF, Multipage TIFF, PDF, PDF-A, Multipage PDF, DWF, Multipage DWF, JPEG, CALS
Scan Destination	Local USB (Removable Media), Unlimited IPS Mailboxes (Local), Unlimited FTP, Unlimited SMB
Original Size Width/Length	Originals Up to 42" - 36" / 1,066 mm - 914 mm Scan width
Original Thickness	Up to .6" / 16 mm Automatic thickness detection
Original Face Up/Face Down	Both - Dual Original Feed Tables
Interface	USB 3.0, Super-Speed USB3 Technology (5 GB per sec data transfer)
Dimensions	55" W x 21" D x 11" H / 1,399 mm W, 480 mm D, 310 mm H
Weight	160 lbs / 73 kg
Electrical	100-240V AC 50/60 Hz
Power Consumption	<120 W
Minimum PC Requirements (NOT INCLUDED WITH SCANNER)	Quad Core Processor ( such as an Intel i5 or higher ) Windows 7 / 10 (32 or 64 bit version) 8GB RAM with 64 bit or 3GB RAM 32 bit 1 TB Hard Drive 1 Gig RJ45 LAN Port DVD/CD Optical Drive One USB 3.0 Port (scanner connection) 27" Wide Screen Flat panel monitor USB keyboard and mouse

For more information, reach us at  
315.437.5111 [www.planandprint.com](http://www.planandprint.com) [sales@planandprint.com](mailto:sales@planandprint.com)



**USA:** Phone: (800) 252.6793 | Email: [info@kip.com](mailto:info@kip.com) **CANADA:** Phone: (800) 653.7552 | Email: [info@kipcanada.com](mailto:info@kipcanada.com)

KIP is a registered trademark of the KIP Group. All other product names mentioned herein are trademarks of their respective companies. All product features and specifications are subject to change without notice. Complete product specifications are available upon request. © 2017